



Cambridge International AS & A Level

CANDIDATE
NAME

CENTRE
NUMBER

--	--	--	--	--

CANDIDATE
NUMBER

--	--	--	--



BIOLOGY

9700/35

Paper 3 Advanced Practical Skills 1

October/November 2021

2 hours

You must answer on the question paper.

You will need: The materials and apparatus listed in the confidential instructions

INSTRUCTIONS

- Answer **all** questions.
- Use a black or dark blue pen. You may use an HB pencil for any diagrams or graphs.
- Write your name, centre number and candidate number in the boxes at the top of the page.
- Write your answer to each question in the space provided.
- Do **not** use an erasable pen or correction fluid.
- Do **not** write on any bar codes.
- You may use a calculator.
- You should show all your working and use appropriate units.

INFORMATION

- The total mark for this paper is 40.
- The number of marks for each question or part question is shown in brackets [].

For Examiner's Use	
1	
2	
Total	

This document has **16** pages. Any blank pages are indicated.

Before you proceed, read carefully through the **whole** of Question 1 and Question 2.

Plan the use of the **two hours** to make sure that you finish the whole of Question 1 and Question 2.

- 1 Plant cells contain the enzyme catalase which catalyses the breakdown of hydrogen peroxide, releasing oxygen.

When a mixture of hydrogen peroxide and plant extract is put into a syringe, bubbles of oxygen are released.

You are going to investigate the effect of substrate concentration on the activity of catalase.

You are provided with the materials shown in Table 1.1.

Table 1.1

labelled	contents	hazard	volume/cm ³
H	3.0% hydrogen peroxide solution	irritant	30
P	plant extract solution	none	40
U	unknown concentration of hydrogen peroxide solution	irritant	10
W	distilled water	none	100

If any of the solutions come into contact with your skin, wash off immediately with cold water.

It is recommended that you wear suitable eye protection and wear gloves to protect your hands when using hydrogen peroxide, **H** and **U**.

- (a) You will need to carry out a **serial** dilution of the 3.0% hydrogen peroxide solution, **H**, to reduce the concentration by **half** between each successive dilution.

You will need to prepare **four** concentrations of hydrogen peroxide solution in addition to the 3.0% hydrogen peroxide solution, **H**.

After the serial dilution is completed, you will need to have 10 cm³ of each concentration available to use.

- (i) Complete Fig. 1.1 to show how you will prepare your serial dilution.

Fig. 1.1 shows the first two beakers you will use to make your serial dilution. You will need to draw **three** additional beakers.

For each beaker add labelled arrows to show:

- the volume of hydrogen peroxide solution transferred
- the volume of distilled water, **W**, added.

Under each beaker, state the concentration of hydrogen peroxide solution.

3

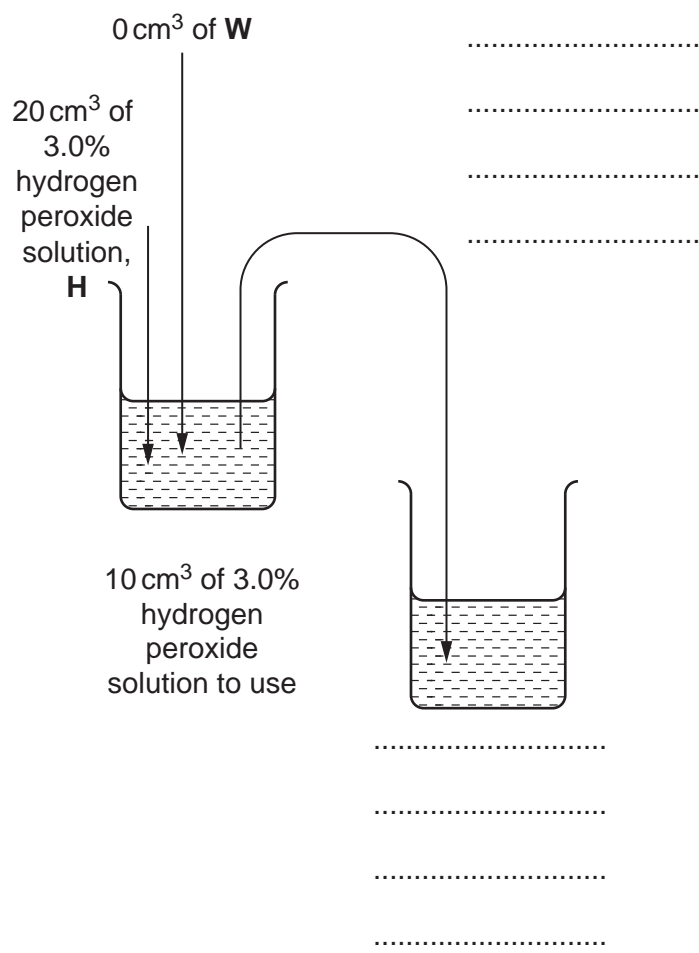

Fig. 1.1

[3]

Carry out step 1 to step 24.

1. Prepare the concentrations of hydrogen peroxide solution, as decided in **(a)(i)**, in the beakers provided.
2. Put **W** into the test-tube so that it is approximately half-full.
3. Use the glass rod to stir the plant extract solution, **P**.
4. Put the nozzle of a clean syringe into the beaker containing **P**.
5. Pull the plunger out to the 1 cm^3 mark so that **P** enters the syringe, as shown in Fig. 1.2.

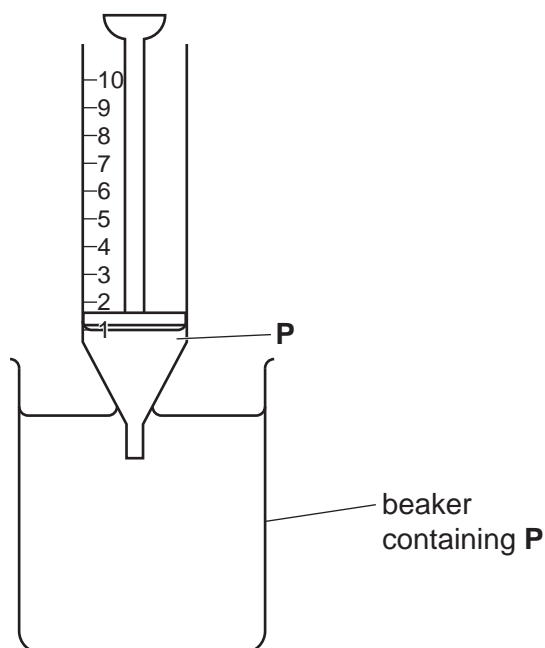

Fig. 1.2

6. Remove the syringe from the beaker containing **P** and wipe the nozzle with a paper towel.
7. Put the nozzle of the **same** syringe into the beaker containing 3.0% hydrogen peroxide solution, **H**.
8. Pull the plunger out to the 2 cm^3 mark so that 1 cm^3 of the 3.0% hydrogen peroxide solution enters the syringe, as shown in Fig. 1.3.

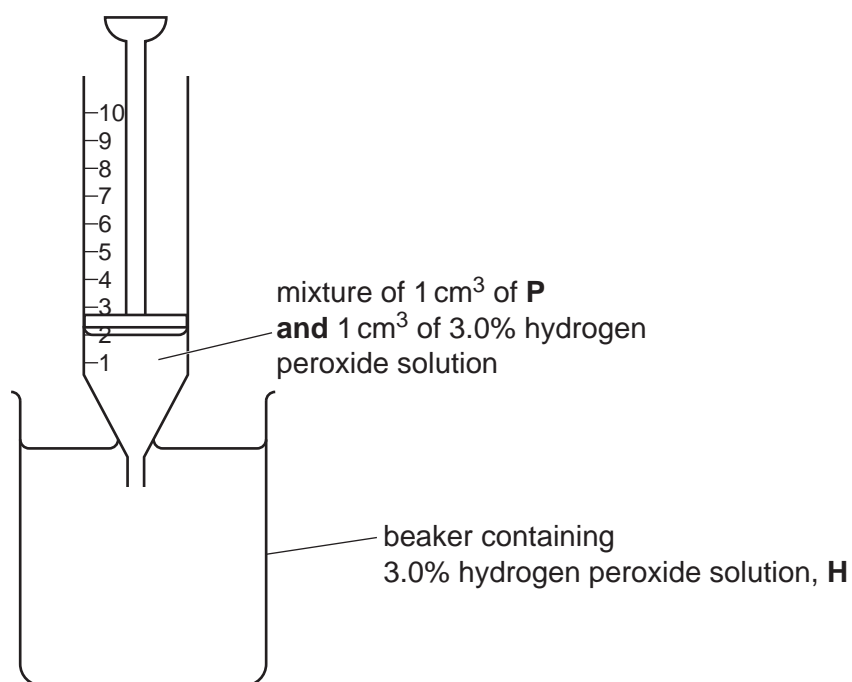

Fig. 1.3

9. Carefully wipe the nozzle with a paper towel to remove excess hydrogen peroxide solution.
10. Put the tubing onto the syringe nozzle.
11. Put the syringe into a beaker as shown in Fig. 1.4.

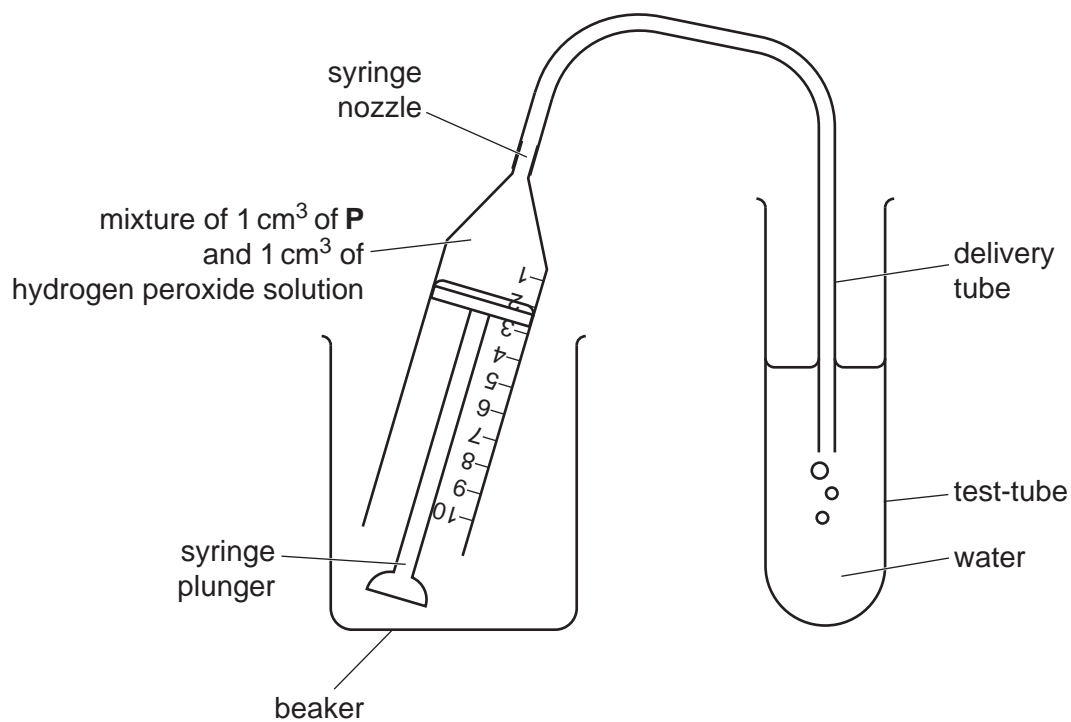

Fig. 1.4

12. Put the end of the delivery tube into the test-tube as shown in Fig. 1.4.
13. Start timing when the first bubble is observed in the water in the test-tube.

6

14. Count the number of bubbles produced in 120 seconds. Record the results in **(a)(ii)**.
15. Hold the syringe with the nozzle up and remove the tubing from the syringe. Put the tubing onto a paper towel.
16. Hold the syringe with the nozzle pointing downwards over the container labelled '**For waste**' and empty the syringe.
17. Fill the syringe with water from the container labelled '**For washing**'.
18. Put the tubing back onto the syringe nozzle.
19. Empty the syringe through the tubing into the container labelled '**For waste**'.
20. Repeat step 15 to step 19 twice more to wash the syringe and the tubing.
21. Remove the tubing from the syringe. Put the tubing onto a paper towel.
22. Repeat step 3 to step 21 with each of the other concentrations of hydrogen peroxide solution prepared in step 1.

(ii) Record your results in an appropriate table.

[5]

23. Repeat step 3 to step 13 with the unknown concentration of hydrogen peroxide solution, **U**.

24. Count the number of bubbles produced in 120 seconds. Record the result in **(a)(iii)**.

(iii) State the number of bubbles produced in 120 seconds for **U**. [1]

(iv) Using your results from **(a)(ii)** and **(a)(iii)** estimate the concentration of **U**.

..... % [1]

(v) The volume of oxygen was measured by counting the number of bubbles.

Suggest why this is a source of error.

.....
 [1]

(vi) Suggest an improvement to the procedure to provide a more accurate measurement of the volume of oxygen produced.

.....

 [1]

(vii) In the procedure described in step 1 to step 14, the effect of the concentration of hydrogen peroxide on catalase activity was investigated.

Describe how you would modify this procedure to investigate the effect of changing pH on the number of bubbles of oxygen produced.

.....

 [2]

8

- (b) A student carried out another investigation into the effect of temperature on the activity of catalase. Test-tubes containing plant extract and hydrogen peroxide were placed in thermostatically controlled water-baths at five different temperatures for 120 seconds.

The results are shown in Table 1.2.

The activity of the enzyme is shown in arbitrary units (au).

Table 1.2

temperature/°C	activity of enzyme/au
15.5	3.4
26.0	6.5
37.5	10.1
45.5	8.2
55.0	1.2

- (i) Plot a graph of the data in Table 1.2 on the grid in Fig. 1.5.

Use a sharp pencil for drawing graphs.

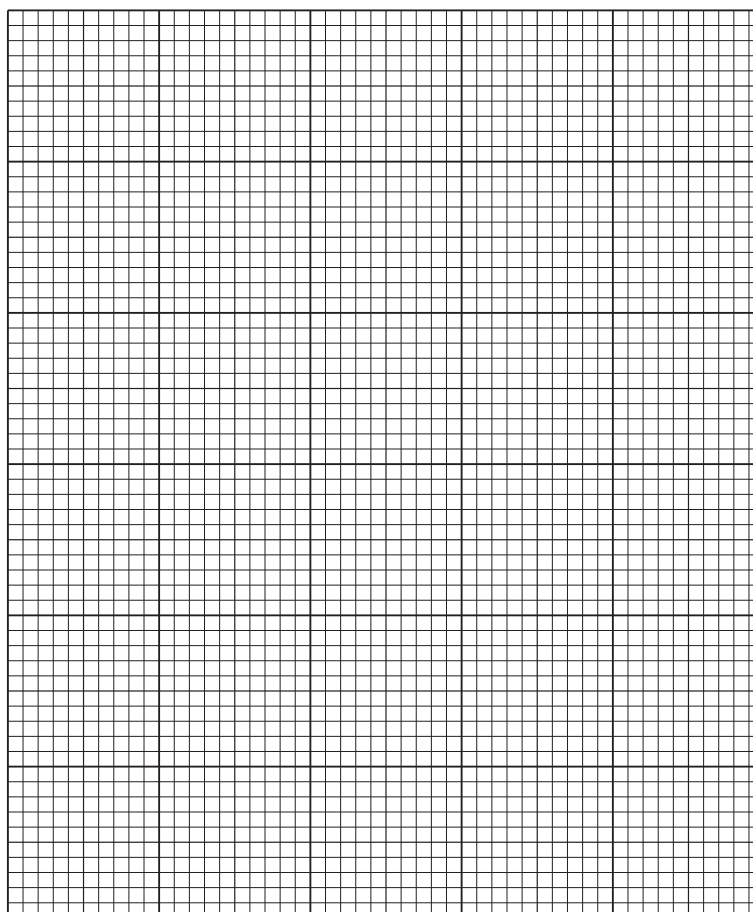

Fig. 1.5

[4]

(ii) Use your graph to find the activity of the enzyme when the temperature was 30.1 °C.

activity of the enzyme = au [1]

(iii) Suggest an explanation for the difference in activity of the enzyme between 37.5 °C and 55.0 °C.

.....
.....
.....
.....
.....
.....
.....
..... [3]

[Total: 22]

10

2 **M1** is a slide of a stained transverse section through a plant stem.

(a) Set up the microscope so that you can observe the section on **M1**.

Use a sharp pencil for drawing.

(i) Draw a large plan diagram of the whole section on **M1**.

Your drawing should show the correct shapes and proportions of the different tissues.

Use **one** ruled label line and label to identify the epidermis.

[5]

(ii) Observe the cells in the central tissue of the section on **M1**.

Select **four** adjacent, touching cells of the central tissue.

Each cell must touch at least two of the other cells.

- Make a large drawing of this group of **four** cells.
- Use **one** ruled label line and label to identify the cell wall of **one** cell.

[5]

- (b) Fig. 2.1 is a photomicrograph of a stained transverse section through a stem of a different type of plant.

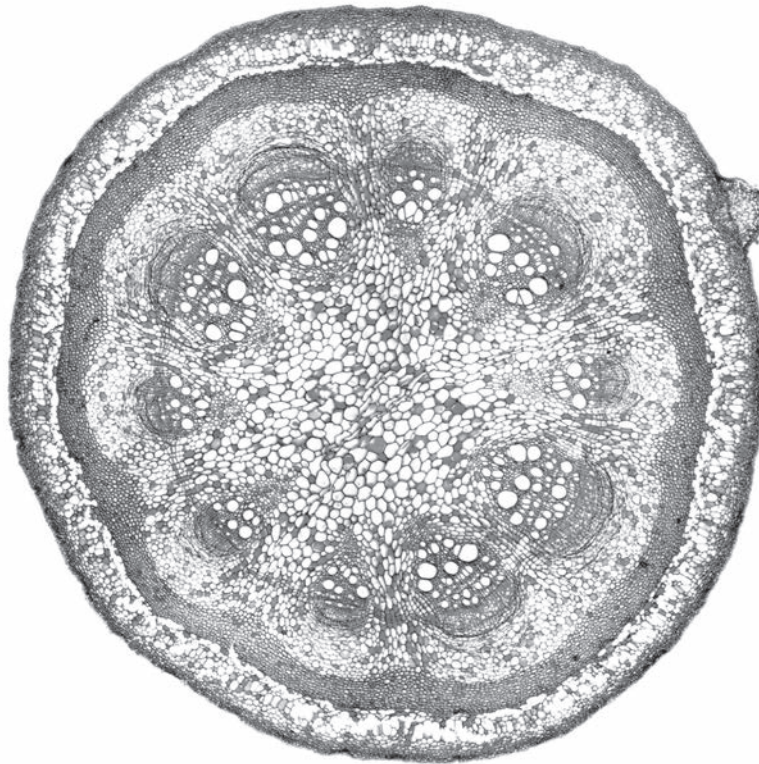

Fig. 2.1

Identify the observable **differences** between the section on **M1** and the section shown in Fig. 2.1.

Record the observable differences in Table 2.1.

Table 2.1

feature	M1	Fig. 2.1

[3]

(c) Fig. 2.2 is a photomicrograph of the same plant stem section that is in Fig. 2.1.

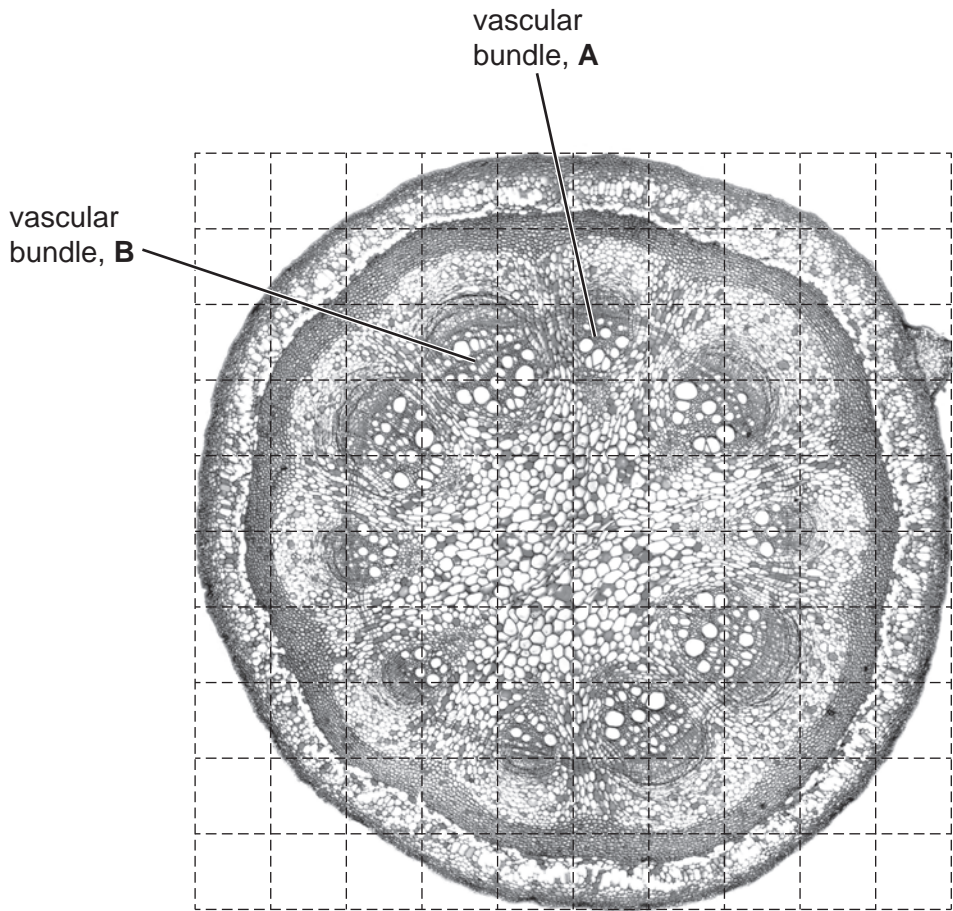

Fig. 2.2

You will need to use the grid to find the area of the vascular bundle labelled **A** and the area of the vascular bundle labelled **B** in Fig. 2.2.

Each square of the grid is 1 cm².

Some of the squares are not completely filled with vascular bundle tissue.

(i) Describe the method you will use to decide which of these squares to include.

.....

 [1]

(ii) Use the grid to estimate the area of the vascular bundle labelled **A** and the area of the vascular bundle labelled **B** in Fig. 2.2.

area of vascular bundle **A** = cm²

area of vascular bundle **B** = cm²
 [2]

15

- (iii) Calculate the area of vascular bundle **A** as a percentage of the area of vascular bundle **B**.
Show your working.

answer = % [2]

[Total: 18]

BLANK PAGE

Permission to reproduce items where third-party owned material protected by copyright is included has been sought and cleared where possible. Every reasonable effort has been made by the publisher (UCLES) to trace copyright holders, but if any items requiring clearance have unwittingly been included, the publisher will be pleased to make amends at the earliest possible opportunity.

To avoid the issue of disclosure of answer-related information to candidates, all copyright acknowledgements are reproduced online in the Cambridge Assessment International Education Copyright Acknowledgements Booklet. This is produced for each series of examinations and is freely available to download at www.cambridgeinternational.org after the live examination series.

Cambridge Assessment International Education is part of the Cambridge Assessment Group. Cambridge Assessment is the brand name of the University of Cambridge Local Examinations Syndicate (UCLES), which itself is a department of the University of Cambridge.